

Klacci®

Architectural Locks & Hardware

LI Series Lever Locks

ANSI Grade 2 Heavy Duty

TRIMS



Type I



Type II



FEATURES

- > Concise and compact design for quick and easy installation, no unique or special tool is required.
- > Through-bolts mounting, inside rose liner with multi-angle screw holes suits either new or retrofitting existing installation without boring or drilling additional holes.
- > Threaded outside rose adjustable for door thickness without removing keyed lever.
- > Independent return springs in both side hubs provide extra resistance to lever sag.
- > Snap-on roses without exposed mounting screws.
- > Internal steel mechanisms are corrosion treated for normal atmospheric conditions.
- > Reversible for either hand of door.

T 886 6 3840722

F 886 6 3840715

18 Gungye 3rd Road, Annan, Tainan 709, Taiwan.
sd@klacci.com

life unlocked

www.klacci.com

Klacci is a registered brand of I-Tek Metal Manufacturing, Co., Ltd. Taiwan.

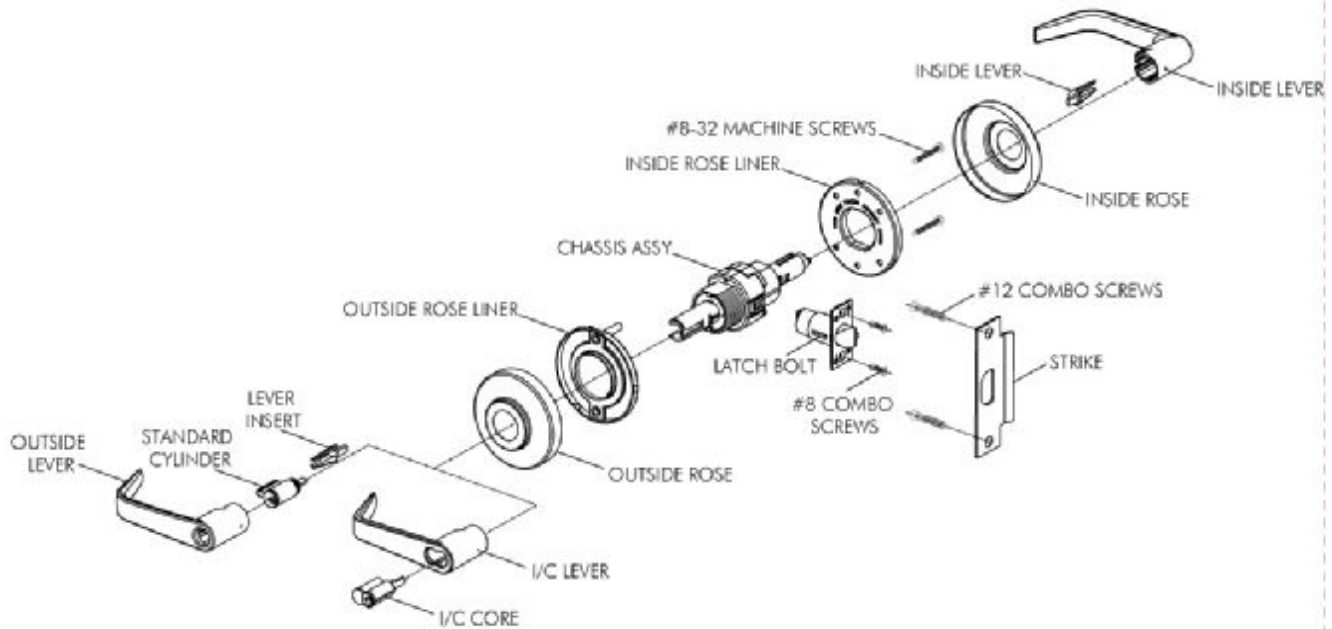















FEATURES

- > Concise and compact design for quick and easy installation, no unique or special tool is required.
- > Through-bolts mounting, inside rose liner with multi-angle screw holes suits either new or retrofitting existing installation without boring or drilling additional holes.
- > Threaded outside rose adjustable for door thickness without removing keyed lever.
- > Independent return springs in both side hubs provide extra resistance to lever sag.
- > Snap-on roses no exposed mounting screws.
- > Internal steel mechanisms are corrosion treated for normal atmospheric conditions.
- > Reversible for either hand of door.

SPECIFICATIONS

Applications	Heavy duty commercial, institutional, governmental buildings and other public accommodations or private entities.
Door Thickness	1 3/8" to 2" thick wood or metal door.
Backset	2 3/4" standard, 2 3/8", 3 3/4" and 5" optional.
Latchbolt	1/2" throw, UL listed, faceplate self-adjusted.
Handing	Non-handed
Strike	ANSI strike standard, T-strike or Full lip strike optional.
Trim	Solid zinc diecast levers, wrought brass roses, concealed screws.
Door Preparation	ANSI A115.2, Through bolted installation.
Cylinder	6-pin "C" keyway standard, two keys per lock, compatible with Schlage® cylinders.
Master Keying	Can be masterkeyed or grand masterkeyed. Construction key systems available.
I/C Core	6 or 7-pin, Compatible with Best® and Falcon® cores.
Finishes	605, 606, 612, 613, 625 and 626
Certifications	UL listed for "A" label(3-hour)single swinging door(4' x 8') ITS certified for ANSI/BHMA A156.2, Series 4000 Grade 2.

FUNCTIONS			
LOCATION CODE NUMBER	FUNCTION	OPERATIONS	ANSI NUMBER
	LI SERIES		
ENTRY / OFFICE LOCK 01		Turn / Push button locking. Pushing and turning button locks outside lever requiring use of key until button is manually unlocked. Pushing button locks outside lever until unlocked with key or inside lever is turned.	F81
STORE DOOR LOCK 02		Deadlocking latchbolt operated by lever from either side, except when both levers are locked by key in lever from either side.	F91
CLASSROOM LOCK 03		Deadlocking latchbolt operated by lever from either side except when outside lever is locked from outside by key. When outside lever is locked, latchbolt is operated by key in outside lever or by rotating inside lever.	F84
COMMUNICATING LOCK 04		Deadlocking latchbolt operated by lever from either side. Turning key in either lever locks or unlocks its own lever independently.	F80
STOREROOM LOCK 05		Deadlocking latchbolt operated by key in outside lever or rotating inside lever. Outside lever is always fixed.	F86
VESTIBULE LOCK 06		Deadlocking latchbolt operated by lever from either side except when outside lever is locked by key from inside, latchbolt may be retracted by key in outside lever or by rotating inside lever.	F88
INSTITUTIONAL LOCK 09		Deadlocking latchbolt operated by key in lever from either side. Both levers always fixed.	F87
HOTEL / MOTEL LOCK H1		Deadlocking latchbolt operated by lever from inside at all times. Outside lever always fixed. Latchbolt operated by key from outside except when push button inside is operated thus shutting out all keys except emergency key. Inside push button provides lockout feature by keeping indicator thrown. Turning inside lever or closing door releases indicator and shut out feature.	F93
PATIO LOCK 10		Deadlocking latchbolt operated by lever from either side. Outside lever is locked by push button inside and unlocked by rotating inside lever or closing door.	F77
PRIVACY LOCK 20		Latchbolt operated by lever from either side. Outside lever is locked by push button inside and unlocked by emergency release outside, rotating inside lever or closing door.	F76
PASSAGE / CLOSET SET 30		Latchbolt operated by lever from either side at all times.	F75
SINGLE DUMMY TRIM 40		Single dummy trim for one side of door.	
EXIT LATCH 50		Deadlocking latchbolt by inside lever. Outside lever rigid.	F89
CONNECTING ROOM / EXIT LOCK 60		Deadlocking latchbolt operated from inside only. Blank plate outside.	
CONNECTING ROOM / EXIT LOCK 63		Deadlocking latchbolt operated by lever from inside except when inside lever is locked by key. Blank plate outside.	

CYLINDERS

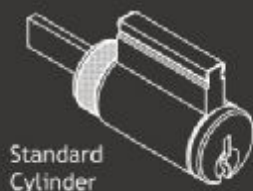

Standard
Cylinder

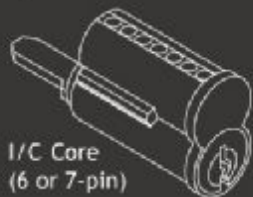

1/C Core
(6 or 7-pin)

STRIKES



ANSI Strike #D27
4 7/8" x 1 1/4"
Lip length 1 1/4"



T-Strike #B27
2 3/4" x 1 1/8"
Lip length 1 1/8"



Full Lip Strike, #C27
2 1/4" x 1 3/4"
Lip length 1 1/4"

LATCHES

Grade 2 latches are 1/2" throw, 7/8" diameter housings and faceplate self-adjusted.



Deadlatch
1/2" Throw
2 1/4" x 1 1/8"



Spring latch
1/2" Throw
2 1/4" x 1 1/8"



Sleeve
1" diameter

EXTENSION LINKS

To join appropriate extension link with 2 3/8" backset latch for required backset.

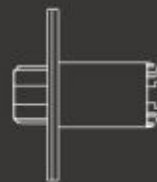

3 3/4" Backset



5" Backset

HOW TO ORDER

LI	10	01	626	4	D27	KD	
Series	Trims	Function Code	Finishes	Backsets	Strike Types	Keying	
LI Series	10—Type I 11—Type I 20—Type II 21—Type II	STD 1/C STD 1/C	See page 3	605 606 612 613 625 626	8—2 3/8" 4—2 3/4" 3—3 3/4" 5—5"	D27 — ANSI Strike B27 — T Strike C27 — Full lip Sq. Corner CR27— Full lip 1/4" R. Corner	KD AK KA